

Slim timed sockets for 34 series, 6.2 mm wide

- Timer adjustment via top mounted rotary knob accessible after assembly
- Control signal terminal
- DIP-switch for selection of 4 time scales and 8 functions
- Output with fuse module option
- EMR and SSR: 12 to 24 V AC/DC supply
- Screw terminal and push-in terminal

93.68
Screw terminals



93.69
Push-in terminal



- Time scale: from 0.1 s to 6 h
- Multi-function
- For use with 34.51 (EMR) and 34.81 (SSR) relays
- Screw terminal and push-in terminal

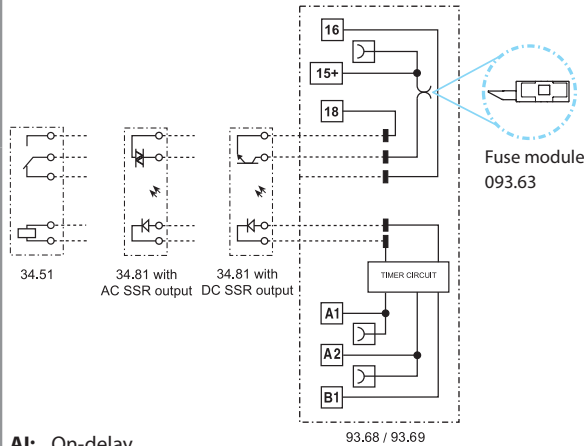

- A1:** On-delay
- D1:** Interval
- G1:** Pulse (0.5 s) delayed
- SW:** Symmetrical flasher (starting pulse on)
- BE:** Off-delay with control signal
- CE:** On- and off-delay with control signal
- DE:** Interval with control signal on
- EE:** Interval with control signal off

For outline drawing see page 3

Contact specification

Contact configuration	
Rated current/Maximum peak current	A
Rated voltage/ Maximum switching voltage	V AC
Rated load AC1	VA
Rated load AC15 (230 V AC)	VA
Single phase motor rating (230 V AC)	kW
Breaking capacity DC1: 30/110/220 V	A
Minimum switching load	mW (V/mA)
Standard contact material	

See 34.51 and 34.81 relays

Supply specification

Nominal voltage (U _N)	V AC (50/60 Hz)/DC
Rated power AC/DC	VA/W
Operating range	V AC (50/60 Hz)/DC

12...24

See coils specifications page 2

9.6...26.4

Technical data

Specified time range	
Repeatability	%
Recovery time	ms
Setting accuracy - full range	%
Electrical life at rated load in AC1	cycles
Ambient temperature range	°C
Protection category	

(0.1...3)s, (3...60)s, (1...20)min, (0.3...6)h

± 1

≤ 50

5

See 34.51 (EMR) and 34.81 (SSR) relays

-20...+50

IP 20

Approvals (according to type)



Ordering information

Example: type 93.68 multi-function timer module for 34 series relay, screw terminals, (12...24)V AC/DC supply voltage.

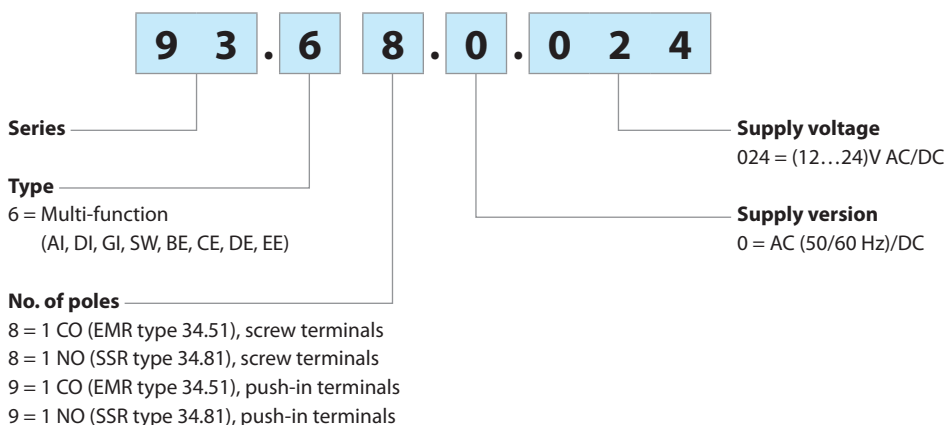

Combinations

Output	Supply voltage	Type of relay	Type of socket, screw terminals
1 pole 6 A, electromechanical relay	12 V AC/DC	34.51.7.012.0010	93.68.0.024
1 pole 6 A, electromechanical relay	24 V AC/DC	34.51.7.024.0010	93.68.0.024
1 output 6 A/24 V DC, solid state relay	12 V AC/DC	34.81.7.012.9024	93.68.0.024
1 output 2 A/240 V AC, solid state relay	12 V AC/DC	34.81.7.012.8240	93.68.0.024
1 output 6 A/24 V DC, solid state relay	24 V AC/DC	34.81.7.024.9024	93.68.0.024
1 output 2 A/240 V AC, solid state relay	24 V AC/DC	34.81.7.024.8240	93.68.0.024
Output	Supply voltage	Type of relay	Type of socket, push-in terminals
1 pole 6 A, electromechanical relay	12 V AC/DC	34.51.7.012.0010	93.69.0.024
1 pole 6 A, electromechanical relay	24 V AC/DC	34.51.7.024.0010	93.69.0.024
1 output 6 A 24 V DC, solid state relay	12 V AC/DC	34.81.7.012.9024	93.69.0.024
1 output 2 A 240 V AC, solid state relay	12 V AC/DC	34.81.7.012.8240	93.69.0.024
1 output 6 A 24 V DC, solid state relay	24 V AC/DC	34.81.7.024.9024	93.69.0.024
1 output 2 A 240 V AC, solid state relay	24 V AC/DC	34.81.7.024.8240	93.69.0.024

Note: Although the timer socket covers both 12 and 24 V supplies, it must be combined with the appropriate 12 V or 24 V relay; resulting in a combination suitable for just a single supply voltage.

Technical data

EMC specifications

Type of test	Reference standard		
Electrostatic discharge	contact discharge	EN 61000-4-2	4 kV
	air discharge	EN 61000-4-2	8 kV
Radio-frequency electromagnetic field	(80 ÷ 1000 MHz)	EN 61000-4-3	10 V/m
	(1400 ÷ 2700 MHz)	EN 61000-4-3	10 V/m
Fast transients (burst) (5-50 ns, 5 and 100 kHz)	on Supply terminals	EN 61000-4-4	4 kV
	on control signal terminals	EN 61000-4-4	4 kV
Surges (1.2/50 µs) on supply and control signal terminals	common mode	EN 61000-4-5	2 kV
	differential mode	EN 61000-4-5	0.8 kV
Radio-frequency common mode (0.15 ÷ 80 MHz)	on Supply terminals	EN 61000-4-6	10 V
	on control signal terminals	EN 61000-4-6	3 V
Radiated and conducted emission	EN 55022	class B	

Other data

Current absorption on signal control (B1)	mA	< 1.7 (12 V) - < 3.5 (24 V)	
Bounce time (EMR) : NO/NC	ms	1/6	
Vibration resistance (EMR, 10...55 Hz): NO/NC	g	10/5	
Power lost to the environment	without contact current	W	0.3
	with rated current	W	0.8

Terminals

	Solid and stranded cable		
	Screw terminals	Push-in terminals	
Wire strip length	mm	10	8
 Screw torque	Nm	0.5	—
Max. wire size	mm ²	1 x 2.5 / 2 x 1.5	1 x 2.5
	AWG	1 x 14 / 2 x 16	1 x 14
Min. wire size	mm ²	1 x 0.5	1 x 0.5
	AWG	1 x 21	1 x 21

Input specifications

Input data AC/DC timer

Nominal voltage U_N	Operating range (AC/DC)		Must drop-out voltage U_r	Rated input current at U_N		Rated power at U_N	
	U_{min}	U_{max}		DC	AC	DC	AC
V	V	V	V	mA	mA	mA	mA
12	9.6	13.2	1.2	15	23	0.2	0.3/0.2
24	19.2	26.4	2.4	11	19	0.25	0.4/0.3

Outline drawing

93.68
Screw terminals

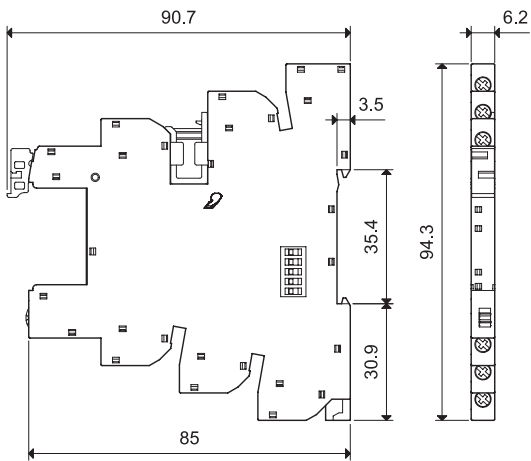

93.69
Push-in terminal

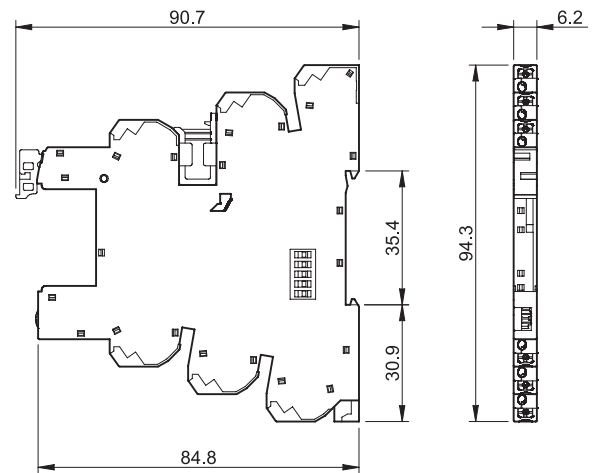

Times scales



Functions

LED	Supply voltage	NO contact/output
	OFF	Open
	ON	Open
	ON	Open (timing to close in progress)
	ON	Closed

Wiring diagram

U = Supply voltage

S = Signal switch

= Output Contact

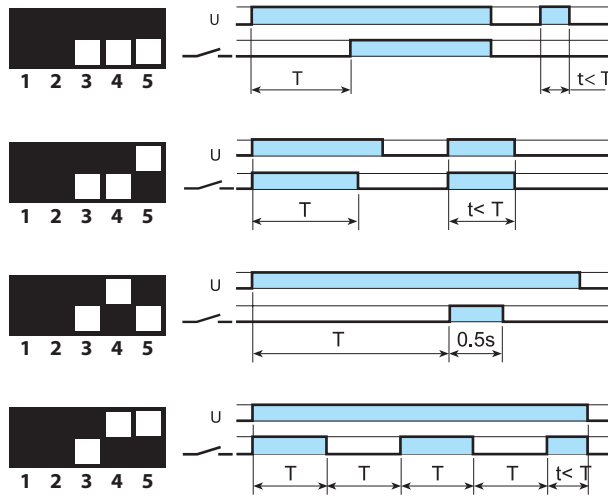
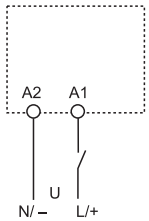

(AI) On-delay

Apply power to timer. Output contacts transfer after preset time has elapsed. Reset occurs when power is removed

(DI) Interval

Apply power to timer. Output contacts transfer immediately. After the preset time has elapsed, contacts reset.

(GI) Pulse (0.5 s) delayed

Apply power to timer. Output contacts transfer after preset time has elapsed. Reset occurs after a fixed time of 0.5 s.

(SW) Symmetrical flasher (starting pulse on)

Apply power to timer. Output contacts transfer immediately and cycle between ON and OFF for as long as power is applied. The ratio is 1:1 (time on = time off).

H

With control signal

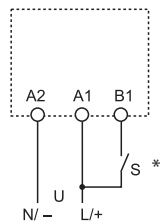

* With DC supply, positive polarity has to be connected to B1 terminal (according to EN 60204-1).

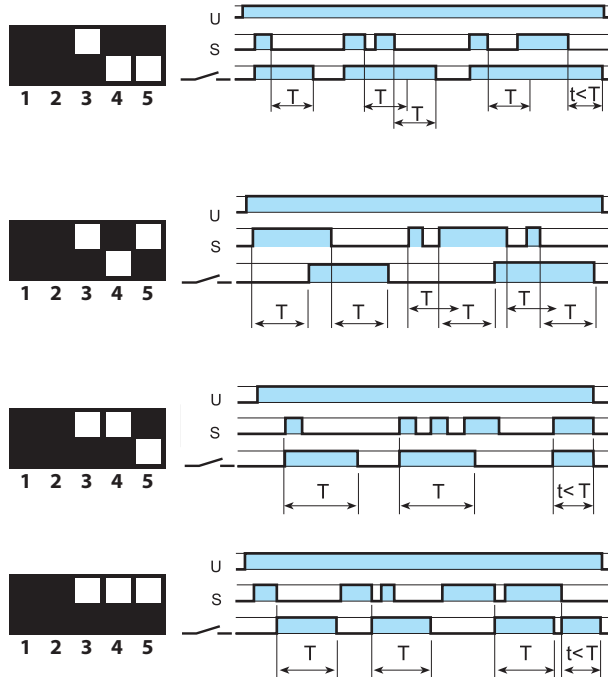

(BE) Off-delay with control signal

Power is permanently applied to the timer. The output contacts transfer immediately on closure of the Signal Switch (S). Opening the Signal Switch initiates the preset delay, after which time the output contacts reset.

(CE) On- and off-delay with control signal

Power is permanently applied to the timer. Closing the Signal Switch (S) initiates the preset delay, after which time the output contacts transfer. Opening the Signal switch initiates the same preset delay, after which time the output contacts reset.

(DE) Interval with control signal on

Power is permanently applied to the timer. On momentary or maintained closure of Signal Switch (S), the output contacts transfer, and remain so for the duration of the preset delay, after which they reset.

(EE) Interval with control signal off

Power is permanently applied to the timer. On opening of the Signal Switch (S) the output contacts transfer, and remain so for the duration of the preset delay, after which they reset.

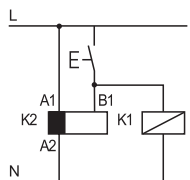

• Possible to control an external load, such as another relay coil or timer, connected to the control signal terminal B1.

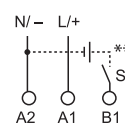

** A voltage other than the supply voltage can be applied to the command Start (B1), example:
A1 - A2 = 24 V AC
B1 - A2 = 12 V DC

Accessories

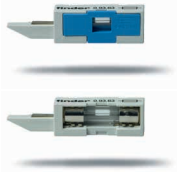

093.63

Approvals
(according to type):



Output fuse module	093.63
---------------------------	--------

- For 5 x 20 mm fuses up to 6 A, 250 V
- Easy visibility of the fuse condition through the window
- Quick connection to socket

Notes

Safety: Because the output circuit can be reinstated, even with the fuse removed, it is important not to consider the removal of the fuse as a "safety disconnect". Always isolate elsewhere before working on the circuit.

UL: According to UL508A, the fuse module cannot be installed in power circuits (in which it is mandatory that a fuse certified according to UL category JDDZ be fitted). However, where the MasterInterface is connected as an output interface to a PLC no such restrictions apply, and the fuse module can be usefully employed.

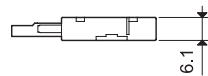
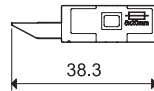

093.16



093.16.0



093.16.1

Approvals
(according to type):



16-way jumper link	093.16 (blue)	093.16.0 (black)	093.16.1 (red)
---------------------------	---------------	------------------	----------------

Rated values	6 A - 250 V
--------------	-------------

Possibility of multiple connection, side by side

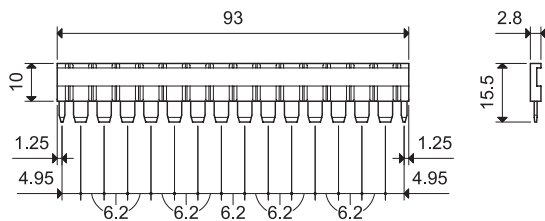

093.60



Dual-purpose plastic separator (1.8 mm or 6.2 mm separation)	093.60
---	--------

- By breaking off the protruding ribs (by hand), the separator becomes only 1.8 mm thick; useful for the visual separation of different groups of interfaces, or necessary for the protective separation of different voltages of neighbouring interfaces, or for the protection of cut ends of jumper links.

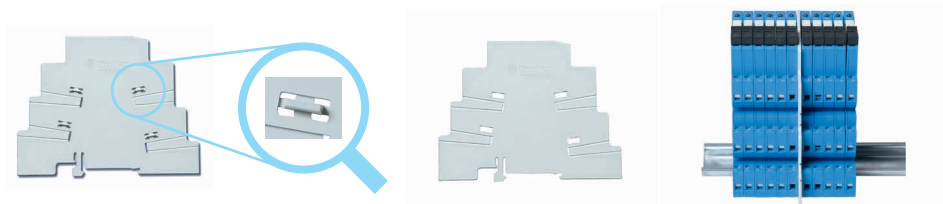

- Leaving the ribs in place provides 6.2 mm separation. Simply cutting (with scissors) the relevant segment(s) permits the interconnection across the separator of 2 different groups of interface relays, using the standard jumper link.

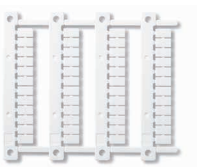

060.48

Sheet of marker tags, plastic, 48 tags, 6 x 12 mm, for CEMBRE thermal transfer printers	060.48
--	--------

Accessories



Terminal doubler (for socket Push-in only)	093.62	
Total load	6 A - 300 V	
Max. wire size	Solid and stranded cable	
	mm ²	2 x 1.5
	AWG	2 x 16



093.68.14.1

Approvals
(according to type):

MasterADAPTER	093.68.14.1	
----------------------	-------------	--

The **MasterADAPTER** permits the easy connection of A1/A2 terminals of up to **MasterINTERFACE** modules to PLC outputs via a 14-Pole ribbon cable, plus simple 2-wire power supply connection.

Technical data

Rated current (per signal path)	A	1
Minimum required supply power	W	3
Nominal voltage (U _N)	V DC	24
Operating range	(0.8...1.1)U _N	
Control logic	Positive switching (to A1)	
Power supply status indication	Green LED	
Ambient temperature range	°C	-40...+70

Terminals for 24 V control logic

Type of connector	14 pole, according to IEC 60603-13	
-------------------	------------------------------------	--

Terminals for 24 V power supply

Wire strip length	mm	9.5	
 Screw torque	Nm	0.5	
Max. wire size	solid wire	mm ²	1 x 4 / 2 x 1.5
		AWG	1 x 12 / 2 x 16
	stranded wire	mm ²	1 x 2.5 / 2 x 1.5
		AWG	1 x 14 / 2 x 16

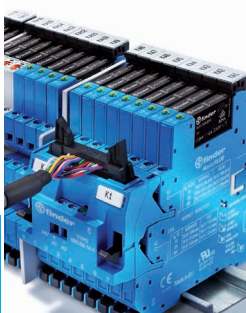
Connected
MasterADAPTER

H